



## Ford Sync 3 Camera Integration Installation and User Manual

Thank you for purchasing the Ford Camera Integration Module.

Before installing be sure to read these instructions.

**Warranty for this product is 2 years from date of purchase, however warranty is void if:**

- Unit is tampered with, damaged or modified
- Any cables in the kit are cut or modified
- Reverse Camera is subjected to overvoltage

### Warranty Terms

The Ford Integration module is covered by warranty for 2 years and includes:

- Defective Equipment
- Defective cables

### Not covered under warranty:

- Abuse
- Water damage
- Improper installation
- Improper use
- Alterations to cables
- Labour
- Accidents
- Postage costs

## Installation Notes

- ◆ This module is to suit the Sync 3 Ford screens.
  - ◆ The wiring and installation of this unit requires special technical skill and experience. If you do not feel confident installing this product or do not have the level of skill necessary, please contact Polaris on 1300 555 514 so we can refer to a recommended installer.
  - ◆ To avoid short circuit in the electrical system, ensure that the negative battery cable is disconnected before installation.
  - ◆ To avoid possibility of shorting out the electrical circuit in the unit, never connect the battery wire directly to the vehicle battery.
  - ◆ Always secure all wirings with cable clamps or adhesive tape to prevent short circuit.
  - ◆ Please make sure all wiring connections are well insulated.
  - ◆ When pulling the dash apart, please use quality trim tools to avoid damaging your dash.
  - ◆ Please do NOT cut any plugs off of any Polaris cameras. Doing so will void your warranty! If you need to blend other brand cameras into our system, please call Polaris on 1300 555 514 so we can refer you to a recommended dealer who has the skill and experience in performing this type of work.
  - ◆ Please do NOT cut any plugs off of any of your OEM Ford Cables as you will void your warranty with Ford.
  - ◆ If there is something you are not 100% sure about when installing this unit, please give our experienced technicians a call on 1300 555 514.
  - ◆ This manual has been written as of February 2022 and is written to the best of our knowledge of the current Ford vehicles. Sometimes vehicles change without notice and is out of our control. If there is something that does not match with your Ford vehicle, please let us know: 1300 555 514
- 

## Videos

**How to pull the Ranger / Everest dash apart and install the module:**

<http://y2u.be/I4dGAyTMh6A>

# How to pull the dash apart to access OEM Head Unit & Screen

This is the recommended order to pull the dash apart:



Please see individual photos below corresponding with their number above:



1. Pull out right hand side small panel

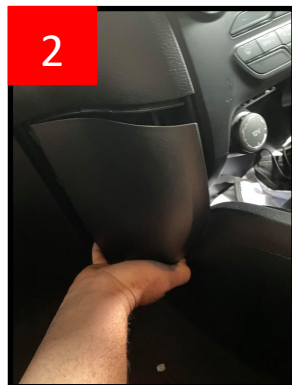

2. Pull out left hand side small panel

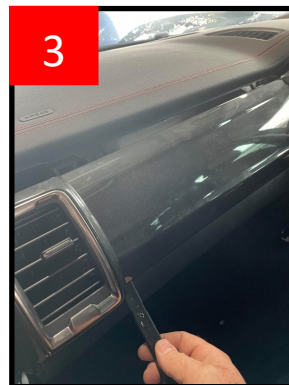

3. Put trim tool underneath the long panel attached to left of OEM screen air vent and pop out



3. Put trim tool under left of OEM screen air vent and pop out



3. Remove entire panel



4. Remove right of OEM screen air vent





5. Place your hand on left side of the long trim and loosen by popping out carefully



5. Place your hand on the long trim directly underneath the monitor and loosen by popping out carefully



5. You should now be able to remove the entire panel with ease

This is the recommended order to pull the final trim off:



Please see individual photos below corresponding with their number above:



1. Unscrew the top 2 screws



2. Unscrew the 2 middle screws



3. Unscrew the 2 bottom screws



4. Pull the 12 volt socket panel out



1. Remove the 2 screws underneath the air conditioning panel



2. Pull the trim off starting at the **BOTTOM**. Pull gently as you will need to disconnect the plugs from the back of the air conditioning panel



3. Remove all plugs from the back of the air conditioning control panel, remove trim and set aside



4. Remove 8 screws to access the back of the monitor and head unit

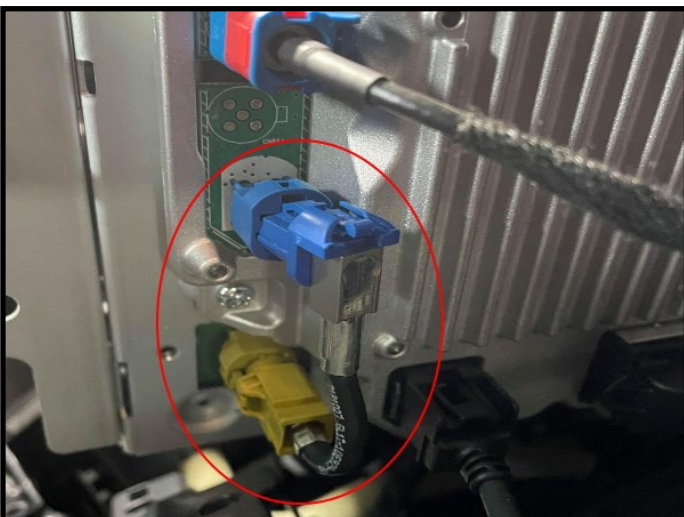

5. On the back of the OEM monitor, remove linking cable (may look different in newer models, please see



6. Keep this cable in case you ever want to revert back to factory standard.

## Linking Cable—Newer Models

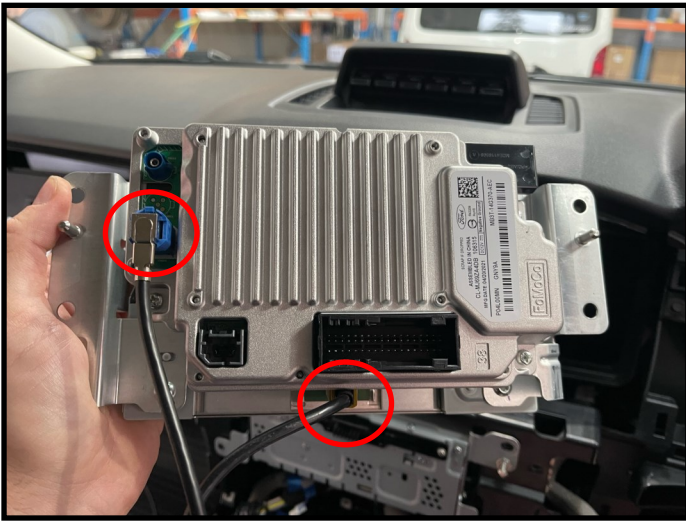

1. In some of the newer models, the linking cable will look a little different

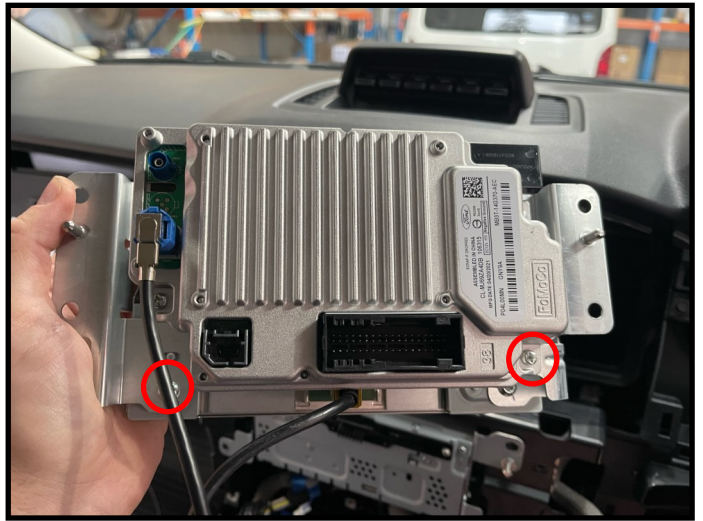

2. Undo the 4 bigger screws to remove the top plate to access the linking cable & unplug

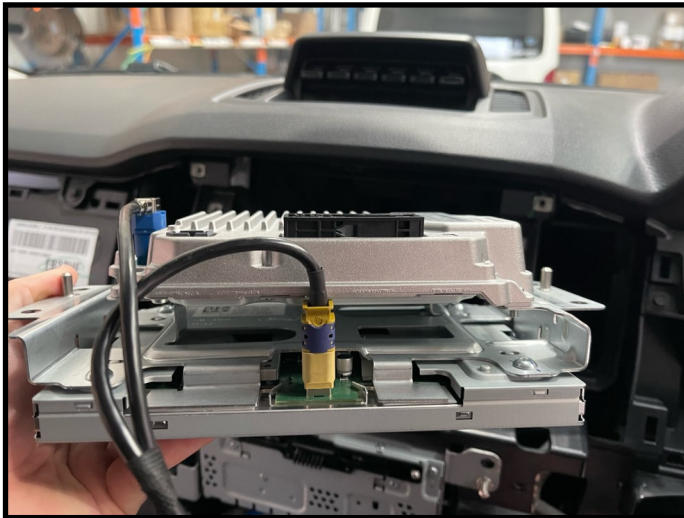

3. Proceed to plug in our linking cable



4. Reattach the top plate

## Polaris Ford Sync 3 Integration module wiring diagram

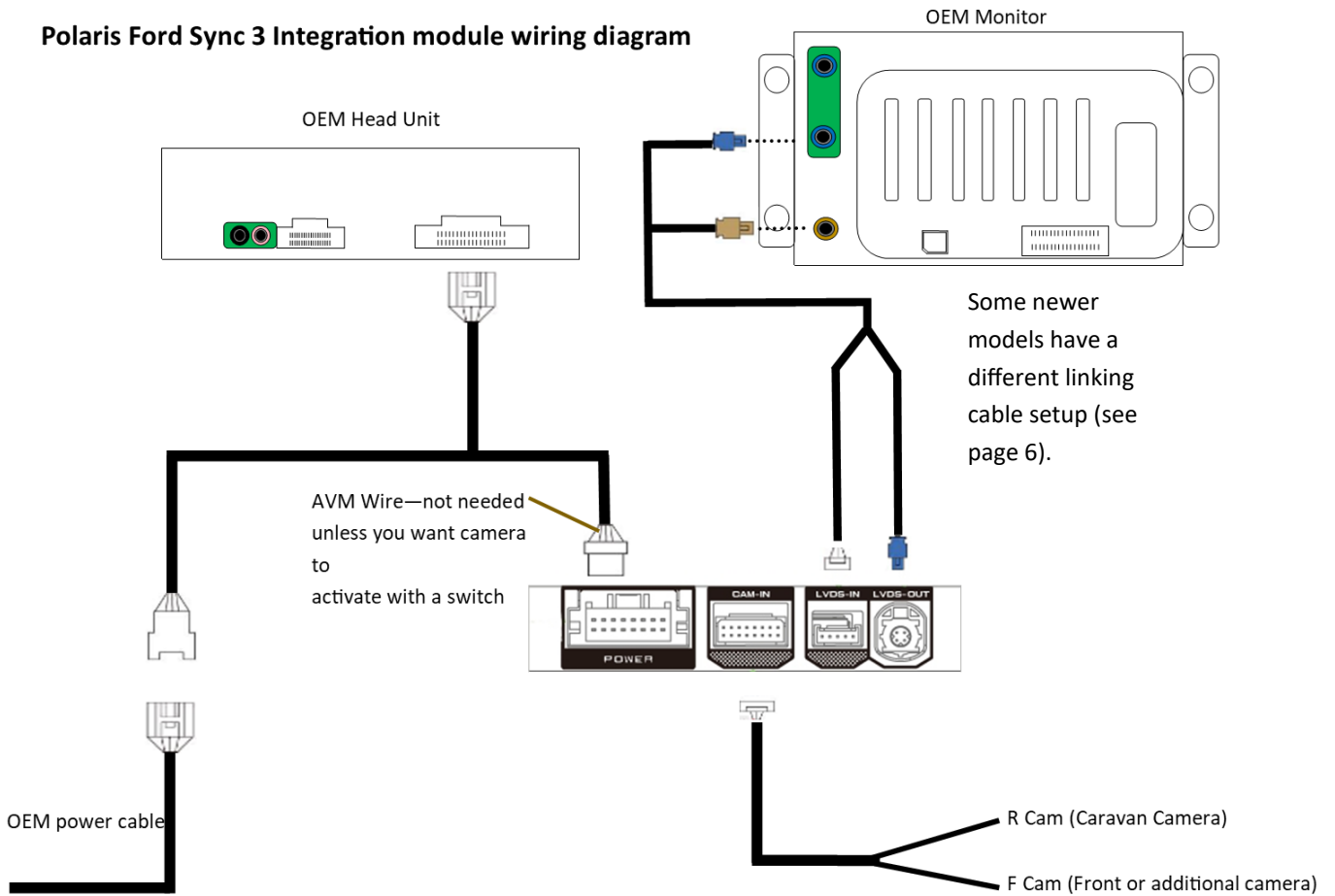

## DipSw Settings

The DipSw settings are already pre-set for a Ford Ranger.

If you are fitting into a another Ford vehicle, please make sure you refer to the DipSw setting and change accordingly.



## DipSw Settings (continued)

DipSw	1	2	3	4	5	6	7	8
UP					<b>See Below</b>			
DOWN	X	X	X	X				

Ford Ranger with Sync 3: 2016 – 2021

DipSw	5	6	7	8
UP				X
DOWN	X	X	X	

Ford Ranger with musical note on steering wheel (see figure 1.)

DipSw	5	6	7	8
UP	X	X	X	X
DOWN				

Ford Everest: 2016 – 2021

DipSw	5	6	7	8
UP		X	X	X
DOWN	X			



**Figure 1.** If your Ford Ranger has a musical note on the left hand side of your steering wheel, please make sure 5,6,7 & 8 DipSw settings are set to ON.

See Page 12 for which steering wheel control activates the camera.



# Camera Wiring

## Polaris Caravan Camera Kit—All Polaris parts

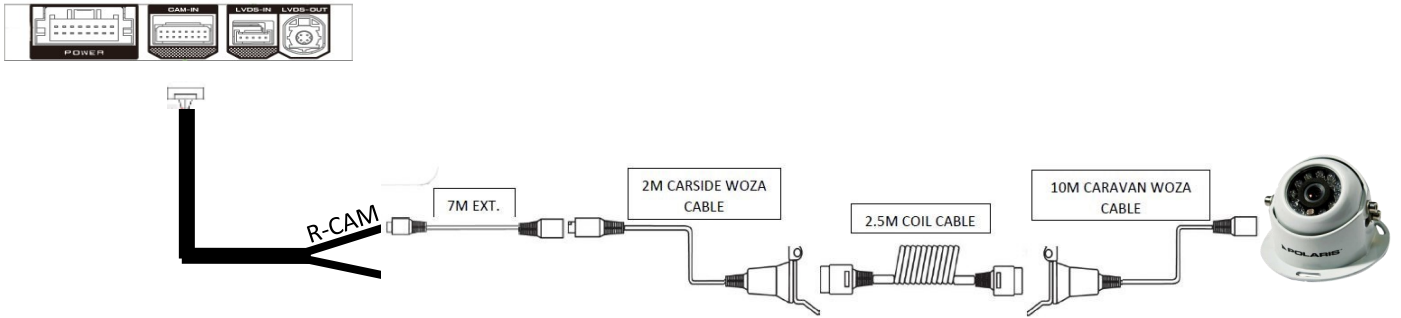

## Caravan Camera Kit—Converting A frame generic style plug to Polaris WOZA socket

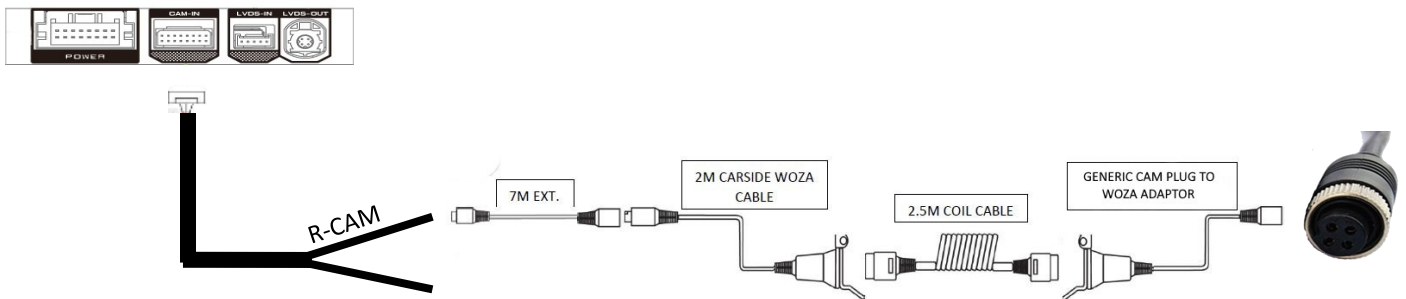

## Caravan Camera Kit—Using an adaptor to plug into A frame generic style plug (NO WOZA setup)

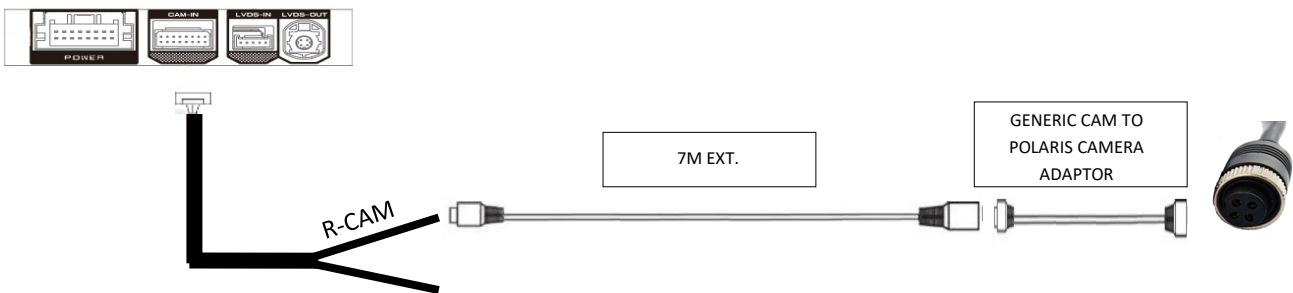

## Front Camera Setup—All Polaris parts

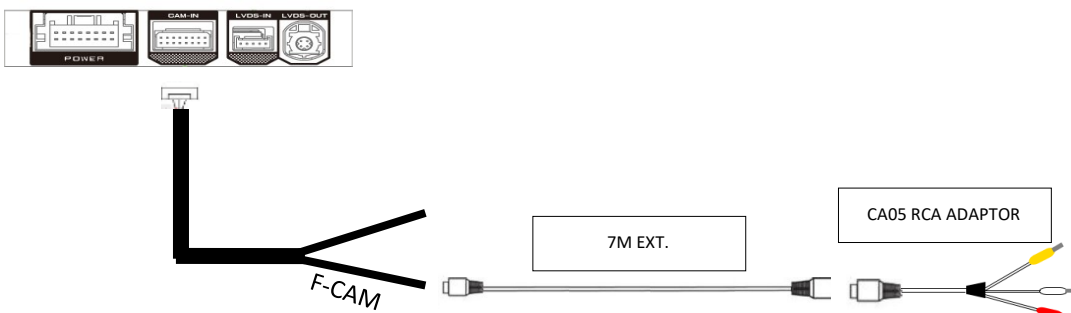

Don't forget to cut the image control wire to change the camera image to forward facing & also pick up power for the camera.



# Programming

Front Camera: Select **5** and select **EXIT** to save

Caravan Camera: Select **EXT** and select **EXIT** to save

Default settings out of box: Front Camera 0 / Reverse Camera EXT

**Important:** The programming setup cannot be accessed in some of the newer 21.25 & 21.75 models. If you are adding a front camera, please contact Polaris for a software update

## Camera Activation—Ford Ranger

Other vehicles steering wheel configuration may differ —See Page 12



**Caravan Camera or Front Camera (one camera)**

Hold in button for 3 seconds



**Interface Setup**

Hold in button for 10 seconds

**(you will activate the caravan camera, keep holding the button in)**



**Back to your main head unit**

Short press button











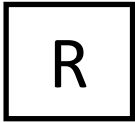









### Caravan Camera & Front Camera (2 cameras)

Hold in ◀ button for 3 seconds: Front Camera will appear first.

Hold in ◀ button for another 3 seconds and caravan camera will appear.

## Reverse Gear Combinations

				
Factory Screen	Select reverse	Factory camera will appear	Hold ◀ button for 3 seconds	Van camera will appear
				
Factory Screen	Hold ◀ button for 3 seconds	Van camera will appear	Select Reverse	Van camera will stay on screen
				
Front Camera	Select Reverse	Factory camera will appear	Select drive	Front Camera will come back on
	or			
Front Camera		Van Camera	Short press ◀ button	Back to factory screen

Videos also available of cam activation on our Youtube Channel: [Polaris GPS & Rear Vision](#)

# Camera Activation—Everest / Ranger with musical note SWC

Ford Everest 2016—2021



Ford Ranger with musical note steering wheel control

