

# POLARIS G52 DVR

Thankyou for purchasing the Polaris G52 DVR. The Polaris G52 DVR is a great product for capturing adventures and incidents both on and off road. This operation manual will guide you through each setting to allow you to set up the best quality videos and photos

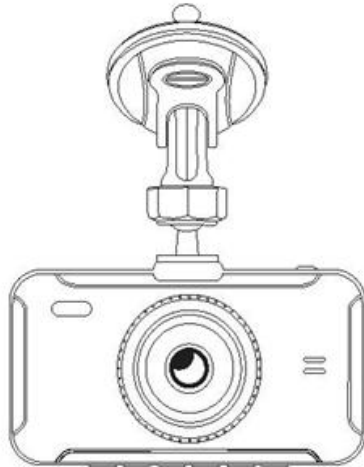

User Manual

## Packing List

QTY	Item
1	G52 Dash cam recorder
2	Cigarette lighter adaptor
3	16G micro SD card
4	Suction cup mount
5	110° Rear camera with 10m extension cable
6	Operation manual

**Important Information: Please format your SD card before use**

## Getting to know your device

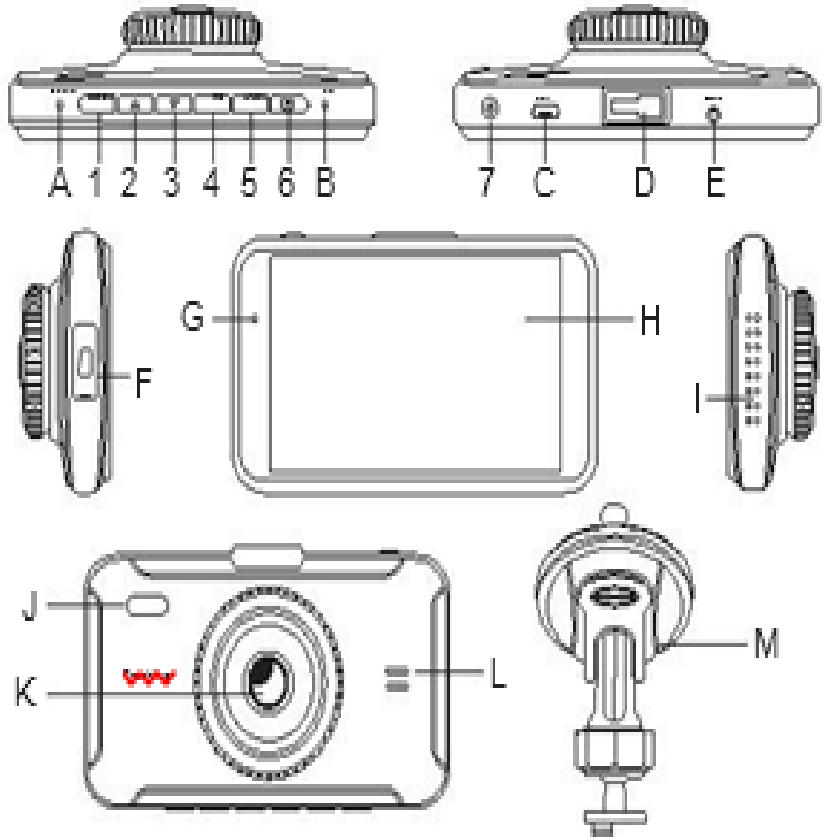

<b>No.</b>	<b>Name</b>	<b>Description</b>
1	Mode	Switch between recording, camera and playback. In recording mode hold for 0.5s to lock video file
2	Down Arrow	In menu option, downward function In recording mode, can capture a photo
3	Up Arrow	In menu option, upward function In recording mode, picture in picture function
4	OK	Use this button to select your desired setting This button will also stop/start recording
5	Menu	Enter or exit devices menu/settings Hold for 0.5s to activate torch
6	Lock	Lock/unlock the video file
7	On/Off	Press once to put screen in sleep mode Hold down to power on/off
A	Reset	Will reboot the device
B	Mic	Microphone
C	USB support	Connects to cigarette lighter adaptor
D	Holder port	For bracket to connect to
E	AV IN	Rear camera socket
F	Micro SD card slot	16G micro SD card supplied
G	Power	Indicator light to show if the device is on/off
H	Screen	4" HD IPS screen
I	Heat dissipation	Avoids overheating
J	Torch	Will help illuminate if image is too dark
K	Camera lens	170° angle
L	Speaker	Voice broadcast
M	Suction bracket	Windscreen mount suction bracket

## List of menu settings

**Important: The unit will automatically record on start up. You cannot access the menu whilst the unit is recording. To stop the recording in order to access the menu settings, press the ok button.**

Setting	Description	Comment
Movie off time	Shuts device down after desired time selected	Options are: Off, 5 sec, 10 sec, 30 sec or 1 minute
Movie clip time	Set up recording time intervals	Can be set to one continuous video or 1, 3 & 5 minute intervals
Movie mode	Set up device resolution	Options are: 720P or 1080P
Sound record	Turn sound on/off	
Language	Select desired language	
Beep	Turn the beep sound on/off when pressing a button on the device	
Volume	Volume of recorded sound	
LCD power save	Does not power the unit off but shuts the screen down after desired time	Options are: Off, 1 minute or 3 minutes
Protect level	Acts as a G sensor	This setting will determine how effective the protect level performs if the device detects a strong impact measured via an accelerated amount of motion. Options are: off, low, medium & high
Parking monitoring	If turned on and a strong impact is detected from an accelerated amount of motion the device will record for 20 seconds & then shutdown	

## List of menu settings

Setting	Description	Comment
Motion Detection	Turn motion detection on/off Options are: Off, low, medium & high	If turned on & motion is detected the device will begin recording. When no motion is detected after 5 secs the device stops recording. <b>Not recommended</b> as the unit is designed to start recording upon start-up regardless of whether it is detecting motion or not. Motion Detection can stop the unit from recording when stationary such as when you are stopped at traffic lights. Not ideal if an accident occurs in this instance.
Reset setup	Restore to default settings	
Format SD card	Will wipe all data from SD card	Recommend to do this upon installation
Clock settings	Set date & time	Press up/down arrow to change & ok to go to the next setting
Exposure	Set your desired exposure	
FW version	View the software version	

## Recording mode

When turned on, the device will start recording instantaneously. To stop recording, press 'OK'. To start recording again, press 'OK'.

The video resolution that is chosen will determine how much recording time you will get out of the SD card, for example the lower the resolution the more storage that will be available on the SD card. This can be changed by entering the 'Menu' and selecting 'Movie Mode'

## Camera mode







Allows you to capture photos with the G52 DVR by pressing the down arrow when recording or not.

## Playback mode

Press the mode button when not recording to access the playback mode.

Here you can view the photos and videos that you have captured.

This feature is a good way to ensure that the device has captured the footage that you need instantaneously without having to retrieve it via an external device.

	Stores any forward facing video file that has not been locked
	Stores any rear facing video file that has not been locked
	Stores forward facing locked files
	Stores rear facing locked files
	Stores forward facing parking monitoring files
	Stores rear facing parking monitoring files
	Stores all still captured photos

## Rear Camera



1. Rear camera receives power from the dash camera when plugged in. You do not have to wire up the red wire to power up the rear camera for recording purposes.
2. Only wire up the red wire to reverse light positive if you would like to use as a reverse camera in addition to a dash camera. When reverse is engaged the reverse camera will override and appear on the 4" screen. The front dash camera will still record in the background.

## Specifications

Video resolution	Front: FHD1080P or 720P Rear: 720P
Storage compression	H.264
Video format	.mov
Picture format	JPEG
Frequency	Dual600MHZ 32-bit RISC
Ram	8GB
LCD Size	4 inches
LCD resolution	800x480
G-Sensor	380B
Working power	4W
SD Card (TF)	Comes with 16GB can take up to 128GB (max) <b>Note: Must be class 10 and must be formatted before use</b>
Voltage:	DC 5V – 36V
Working temperature:	(-20°C~65°C)
Storage Temperature:	(-25°C~75°C)
DVR Video:	HD video, no skip frame, no leak seconds, Good night vision.
Automatic loop time:	1, 3 or 5 minute intervals
Night Vision:	Built in WDR for optimal night vision recording
Record Audio	On/off
Screen protection	On/off

If you have any questions or would like further information please contact our office on 1300 55 55 14 or visit our website at [www.mypolaris.com.a](http://www.mypolaris.com.a)

